

OPERATING MANUAL

αSTEP

**AZ Series Connector Type
Motor Edition**

Table of contents

Introduction	1	Connection	8
Safety precautions	1	Inspection and maintenance	8
Precautions for use	2	Connection cables	9
Preparation	3	General specifications	10
Installation	5	Regulations and standards	10

Introduction

■ Before using the product

Only qualified personnel of electrical and mechanical engineering should work with the product.

Use the product correctly after thoroughly reading "Safety precautions." In addition, be sure to observe the contents described in warning, caution, and note in this manual.

The product described in this manual is designed and manufactured to be incorporated in general industrial equipment. Do not use for any other purpose. Oriental Motor Co., Ltd. is not responsible for any compensation for damage caused through failure to observe this warning.

■ Related operating manuals

For operating manuals, download from Oriental Motor Website Download Page or contact your nearest Oriental Motor sales office.



- **AZ Series Connector Type OPERATING MANUAL Motor Edition** (this document)
- **AZ Series/Motorized Actuator equipped with AZ Series OPERATING MANUAL Function Edition**

Refer to the operating manual of the driver for contents not described in these manuals.

Safety precautions

The precautions described below are intended to ensure the safe and correct use of the product, and to prevent the user and other personnel from exposure to the risk of injury. Use the product only after carefully reading and fully understanding these instructions.

Description of signs



 WARNING	Handling the product without observing the instructions that accompany a "WARNING" symbol may result in serious injury or death.
 CAUTION	Handling the product without observing the instructions that accompany a "CAUTION" symbol may result in injury or property damage.
 Note	The items under this heading contain important handling instructions that the user should observe to ensure safe use of the product.



Thank you for purchasing an Oriental Motor product.





This Operating Manual describes product handling procedures and safety precautions.

- Please read it thoroughly to ensure safe operation.
- Always keep the manual where it is readily available.

Explanation of graphic symbols

	Indicates "prohibited" actions that must not be performed.
	Indicates "compulsory" actions that must be performed.

 WARNING	
	Do not use the product in explosive or corrosive environments, in the presence of flammable gases, or near combustible materials. Doing so may result in fire, electric shock, or injury.
	Do not transport, install, connect or inspect the product while the power is supplied. Doing so may result in electric shock or damage to equipment.
	Do not forcibly bend, pull, or pinch the connection cable. Doing so may result in fire or electric shock.
	Do not disassemble or modify the motor. Doing so may result in injury or damage to equipment.
	Do not machine or modify the connection cable. Doing so may result in fire, electric shock, or damage to equipment.
	Do not apply a strong force to the connector or the terminal. Doing so may damage to the connector or the terminal, resulting in fire, electric shock, or damage to equipment.
	Do not damage the O-ring of the connector. If the O-ring is damaged, IP66 may not be satisfied, resulting in fire, electric shock, or damage to equipment.
	Assign qualified personnel to the task of installing, wiring, operating/controlling, inspecting and troubleshooting the product. Handling by unqualified personnel may result in fire, electric shock, injury or damage to equipment.
	Take measures to hold the moving parts in position if the product is used in vertical operations such as elevating equipment. Failure to do so may result in injury or damage to equipment.
	Do not use the brake mechanism of the electromagnetic brake motor for braking or as a safety brake. Doing so may result in injury or damage to equipment.
	Take measures to hold the moving part in position since the motor will stop and lose its holding force if an alarm is generated in the driver (any of the driver's protective functions is triggered). Failure to do so may result in injury or damage to equipment.
	Install the motor inside an enclosure. Failure to do so may result in electric shock or injury.
	Be sure to ground the AC input type motor as it is Class I equipment. Failure to do so may result in electric shock.

 CAUTION	
	Do not use the motor beyond its specifications. Doing so may result in electric shock, injury, or damage to equipment.
	Keep your fingers and objects out of the openings in the motor. Failure to do so may result in fire, electric shock, or injury.
	Do not touch the motor during operation or immediately after stopping. Doing so may result in a skin burn(s).
	Do not carry the motor by holding the output shaft or the connection cable. Doing so may result in injury.
	Do not place combustibles around the motor. Doing so may result in fire or a skin burn(s).
	Do not leave anything around the motor that would obstruct ventilation. Doing so may result in damage to equipment.
	Do not touch the rotating part (output shaft) while operating the motor. Doing so may result in injury.
	Do not touch the terminals while conducting the insulation resistance measurement or the dielectric strength test. Accidental contact may result in electric shock.
	Provide a cover over the rotating part (output shaft) of the motor. Failure to do so may result in injury.
	Use a motor and a driver only in the specified combination. An incorrect combination may cause a fire.
	Provide an emergency-stop device or emergency-stop circuit external to the equipment so that the entire equipment will operate safely in the event of a system failure or malfunction. Failure to do so may result in injury.
	The motor surface temperature may exceed 70 °C (158 °F) even under normal operating conditions. If the operator is allowed to approach the motor in operation, affix a warning label shown in the figure on a conspicuous position. Failure to do so may result in a skin burn(s).
	 Warning label

Precautions for use

This section explains limitations and requirements the user should consider when using the product.

- **Always use a connection cable of Oriental Motor to connect a motor and a driver.**

Refer to the connection cable models on p.9.

- **Do not apply a strong force to the locking lever.**

If the locking lever is damaged, the connector may not be fixed securely.

- **When conducting the insulation resistance measurement or the dielectric strength test, be sure to separate the connection between the motor and the driver.**

Conducting the insulation resistance measurement or the dielectric strength test with the motor and driver connected may result in damage to the product.

- **Make sure not to hit or apply a strong impact on the output shaft or the encoder (ABZO sensor).**

Applying a strong impact on the output shaft or the encoder (ABZO sensor) may damage to the encoder (ABZO sensor) or cause the motor to malfunction. The warning label shown in the right is affixed on the motor.

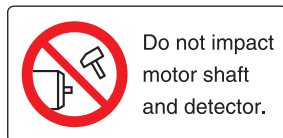

Warning label

- **Do not move the encoder (ABZO sensor) toward a strong magnetic field.**

A magnetic sensor is built into the encoder (ABZO sensor). If the motor is installed close to equipment which generates a strong magnetic field, the encoder (ABZO sensor) may break or malfunction. Make sure to prevent the magnetic flux density on the surface of the encoder (ABZO sensor) from exceeding 10 mT.

- **Meshing noise of mechanical sensor**

A gear type mechanical sensor is built into the encoder (ABZO sensor). Although the meshing noise of gears may generate, it is not malfunction.

- **Use the motor in a state where a radial load and an axial load are equal to or less than the permissible values.**

Continuing to operate the motor under an excessive radial load or axial load may damage the bearings (ball bearings). Be sure to operate the motor below the specified permissible limits of the radial load and the axial load.

- **Holding torque at standstill**

The holding torque is reduced by the current cutback function of the driver when the motor is stopped. When selecting a motor, check the holding torque at motor standstill in the specifications on the catalog.

- **Use the motor in a condition where the motor surface temperature does not exceed 80 °C (176 °F).**

The surface temperature on the motor case may exceed 80 °C (176 °F) depending on operating conditions such as ambient temperature, operating speed, duty cycle, and others. In order to protect the encoder (ABZO sensor), use the motor in conditions where the surface temperature does not exceed 80 °C (176 °F). If the encoder (ABZO sensor) temperature reaches the upper limit, an alarm of the motor overheat will be generated.

Use the geared motor in conditions where the gear case temperature does not exceed 70 °C (158 °F), in order to prevent deterioration of grease and parts in the gear case.

- **Noise elimination measures**

Keep 10 m (32.8 ft.) or less for the wiring distance between a motor and a driver. Extending the wiring distance to more than 10 m (32.8 ft.) may result in heat generation from the driver or increase of the electrical noise emitted from the products including the motor and the cable. Refer to the operating manual of the driver for the noise elimination measures.

- **Do not use the electromagnetic brake for braking or as a safety brake.**

Do not use the electromagnetic brake as a means to brake and stop the motor. The brake hub of the electromagnetic brake will wear significantly and the braking force will drop. Since the power off activated type electromagnetic brake is equipped, it helps maintain the position of the load when the power is cut off, but this brake is not a mechanism to securely hold the load in position. Accordingly, do not use the electromagnetic brake as a safety brake. To use the electromagnetic brake to hold the load in position, do so after the motor has stopped.

- **When operating the motor with key in a state where a load is not installed, make sure to provide measures so that the key is not flown off.**

To fly off the key may result in injury or damage to equipment.

- **Grease of geared motor**

On rare occasions, a small amount of grease may ooze out from the geared motor.

If there is concern over possible environmental damage resulting from the leakage of grease, check for grease stains during regular inspections. Alternatively, install an oil pan or other device to prevent leakage from causing further damage. Oil leakage may lead to problems in the customer's equipment or products.

- **Rotation direction of the gearhead output shaft**

The relationship between the rotation direction of the motor output shaft and that of the gearhead output shaft changes as follows, depending on the gear type and gear ratio.

Type of gear	Gear ratio	Rotation direction compared to motor output shaft
TS geared	3.6, 7.2, 10	Same direction
	20, 30	Opposite direction
FC geared, PS geared, PN geared	All gear ratios	Same direction
Harmonic geared	All gear ratios	Opposite direction

● **Peak torque of geared motor**

Always operate the geared motor under a load not exceeding the peak torque. If the load exceeds the peak torque, the gear will be damaged.

● **Do not perform push-motion operation with geared motor.**

Doing so may cause damage to the motor or gear part.

■ **Notes when the connection cable is used**

Note the following points when a connection cable of Oriental Motor is used.

● **When inserting the connector**

Hold the connector main body, and insert it in straight securely. Inserting the connector in an inclined state may result in damage to terminals or a connection failure.

● **When pulling out the connector**

Hold the connector main body, and pull out it straight. Pulling out the connector with holding the cable may result in damage to the connector.

● **Bending radius of cable**

Use the cable in a state where the bending radius of the cable is more than 2.8 times of the cable diameter. When using a flexible cable, use it in a state where the bending radius of the cable is more than six times of the cable diameter.

● **How to fix the cable**

- Fix the cable at two places near the connectors as shown in the figure or fix it with a wide clamp to take measures to prevent stress from being applied to the connectors.
- Do not bend the lead wires part or secure with a clamp, etc. Doing so may result in damage to the connector.

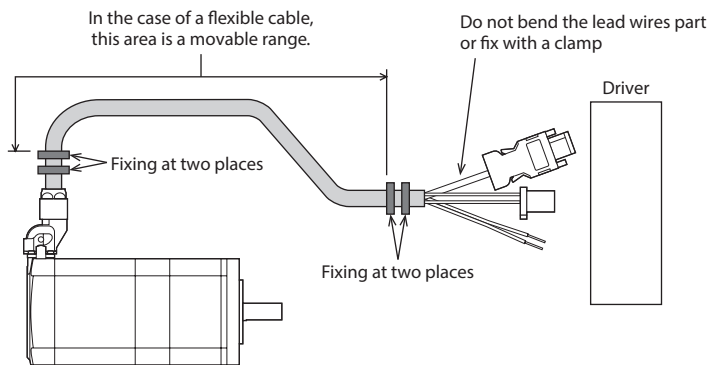

Preparation

■ **Checking the product**

Verify that the items listed below are included. Report any missing or damaged items to the branch or sales office from which you purchased the product.

- Motor 1 unit
- Parallel key 1 pc.*1
- Motor mounting screw (M4)..... 4 pcs.*2
- Instructions and Precautions for Safe Use 1 copy
- APPENDIX UL Standards for **AZ** Series 1 copy

*1 Included with standard type with key and geared type. The **AZM46-TS** type is excluded.

*2 Included with **AZM66-TS**.

■ **How to identify the product model**

Verify the model name of the purchased product against the model shown on the name plate of the product.

● **Standard type**

AZM 6 6 A 0 K H
1 2 3 4 5 6 7

● **Geared type (excluding the FC geared type)**

AZM 6 6 A C H - TS 10 L
1 2 3 4 6 7 8 9 10

1	Series name	AZM: AZ Sereis motor
2	Motor frame size	4: 42 mm (1.65 in.) 6: 60 mm (2.36 in.)
3	Motor length	
4	Motor shaft features	A: Single shaft M: With electromagnetic brake
5	Additional function	0: Round shaft type 1: With key Blank: Round shaft with shaft flat on one side
6	Motor power supply input	C: AC power input type K: DC power input type
7	Motor connection method	H: Connector type
8	Type of gear	TS: TS geared PS: PS geared N: PN geared HS: Harmonic geared
9	Gear ratio	
10	Connector direction* (TS geared type only)	U: Upward direction R: Rightward direction L: Leftward direction Blank: Downward direction

* The connector direction represents that as viewed from the output shaft side in a state where the output shaft is placed upward.

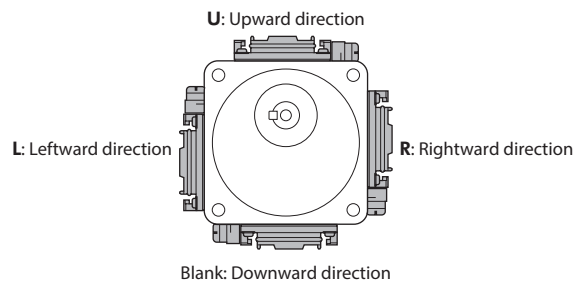

● FC geared type

AZM 6 6 A C H - **FC** 7.2 U A
 1 2 3 4 5 6 7 8 9 10

1	Series name	AZM: AZ Sereis motor
2	Motor frame size	4: 42 mm (1.65 in.) 6: 60 mm (2.36 in.)
3	Motor length	
4	Motor shaft features	A: Single shaft M: With electromagnetic brake
5	Motor power supply input	C: AC power input type K: DC power input type
6	Motor connection method	H: Connector type
7	Type of gear	FC: FC geared
8	Gear ratio	
9	Connector direction*	D: Downward direction U: Upward direction
10	Motor identification	A: Solid shaft

* Check the connector direction as follows.

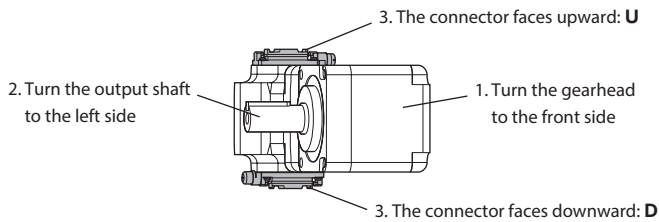

■ Information about nameplate

The figure shows an example.

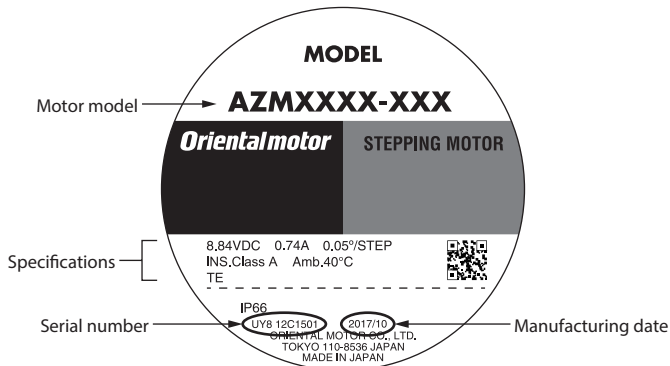

The position describing the information may vary depending on the product.

■ Drivers that can be combined

The motor can be connected to the **AZ** Series drivers (excluding compact drivers and multi-axis drivers).

■ Names of parts

● Standard type with electromagnetic brake (Example: AZM66M1CH)

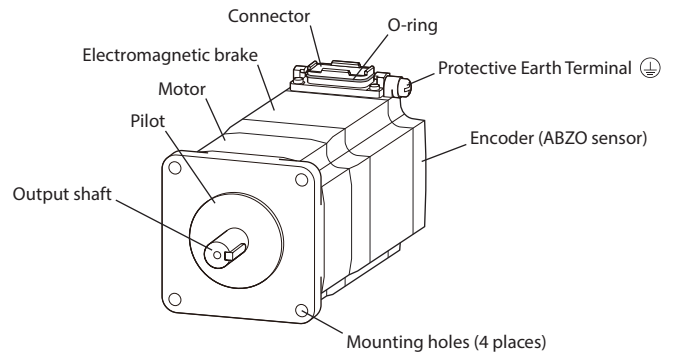

● FC geared type (Example: AZM66ACH-FC7.2UA)

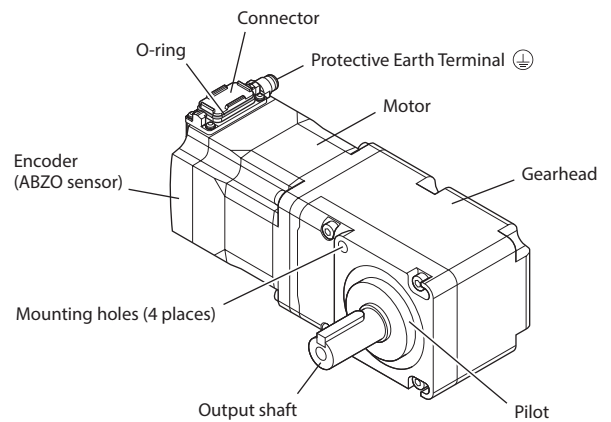

■ About connection cable

To connect a motor and a driver, the dedicated connection cable is required. Purchase is required separately. A connection cable varies depending on a driver combined. Refer to the connection cable models on p.9. The figure shows a cable for the AC power input motor.

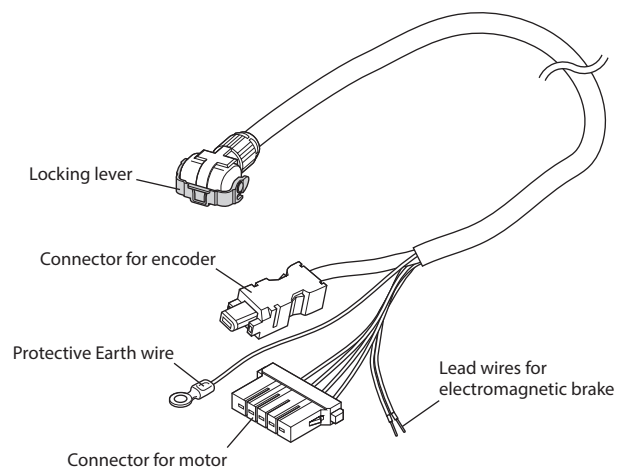

The figure shows the cable for mini Driver.

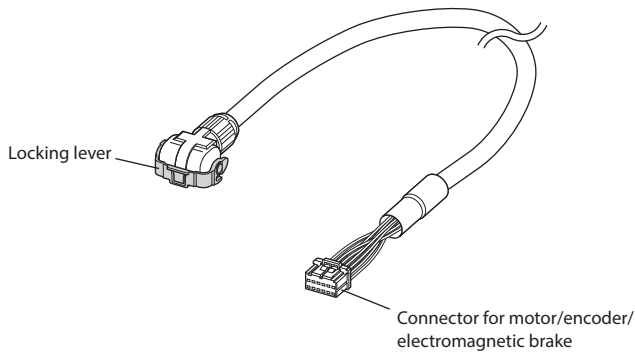

Installation

Installation location

The motor is designed and manufactured to be incorporated in equipment. Install it in a well-ventilated location that provides easy access for inspection. The location must also satisfy the following conditions:

- Inside an enclosure that is installed indoors (provide vent holes)
- Operating ambient temperature: 0 to +40 °C (+32 to +104 °F) (non-freezing)
- Operating ambient humidity: 85 % or less (non-condensing)
- Area free of explosive atmosphere, toxic gas (such as sulfuric gas), or liquid
- Area not exposed to direct sun
- Area free of excessive amount of dust, iron particles or the like
- Area not subject to oil (oil droplets), or other liquids
- Area free of excessive salt
- Area not subject to continuous vibration or excessive shocks
- Area free of excessive electromagnetic noise (from welders, power machinery, etc.)
- Area free of radioactive materials, magnetic fields or vacuum
- Up to 1,000 m (3,300 ft.) above sea level

When a motor is installed in an environment where a magnetic field is generated

A magnetic sensor is built into the encoder (ABZO sensor). If the motor is installed close to equipment which generates a strong magnetic field, the encoder (ABZO sensor) may break or malfunction. Make sure to prevent the magnetic flux density on the surface of the encoder (ABZO sensor) from exceeding 10 mT.

Note Do not install the motor close to equipment which generates a strong magnetic field.

Installation method

The motor can be installed in any direction. To allow for heat dissipation and prevent vibration, install the motor on a metal surface having sufficient strength.

Installation method A

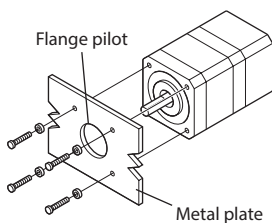

Installation method B

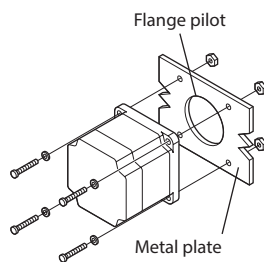

Installation method B (For FC geared type)

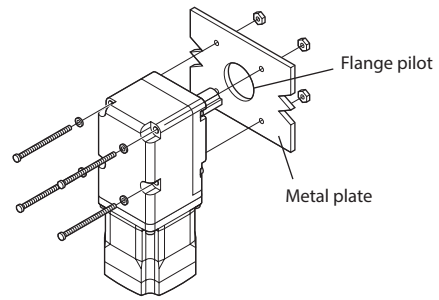

Nominal size, tightening torque and installation method

The values in the tightening torque are recommended. Tighten the screws with a suitable torque according to the design conditions of the metal surface to be installed.

Standard type

Model	Nominal size	Tightening torque [N·m (oz-in)]	Effective depth of screw thread [mm (in.)]	Installation method
AZM46 AZM48	M3	1 (142)	4.5 (0.177)	A
AZM66 AZM69	M4	2 (280)	–	B

TS geared type

Model	Nominal size	Tightening torque [N·m (oz-in)]	Effective depth of screw thread [mm (in.)]	Installation method
AZM46	M4	1.4 (198)	8 (0.315)	A
AZM66	M4	1.4 (198)	–	B

FC geared type

Model	Nominal size	Tightening torque [N·m (oz-in)]	Effective depth of screw thread [mm (in.)]	Installation method
AZM46	M4	2 (280)	–	B
AZM66	M5	2.5 (350)	–	B

PS geared type

Model	Nominal size	Tightening torque [N·m (oz-in)]	Effective depth of screw thread [mm (in.)]	Installation method
AZM46	M4	2 (280)	8 (0.315)	A
AZM66	M5	2.5 (350)	10 (0.394)	A

PN geared type

Model	Nominal size	Tightening torque [N·m (oz-in)]	Effective depth of screw thread [mm (in.)]	Installation method
AZM46	M4	2 (280)	8 (0.315)	A
AZM66	M5	3 (420)	10 (0.394)	A

Harmonic geared type

Model	Nominal size	Tightening torque [N·m (oz-in)]	Effective depth of screw thread [mm (in.)]	Installation method
AZM46	M4	2 (280)	8 (0.315)	A
AZM66	M5	2.5 (350)	10 (0.394)	A

■ Installing a load

When installing a load to the motor, align the rotation axis of the load with the output shaft. When installing a coupling or a pulley on the output shaft, do not damage to the output shaft or the bearings (ball bearing).

● When an electromagnetic brake motor is used

When releasing the electromagnetic brake to install a load, a DC power supply for the electromagnetic brake is necessary. Use the electromagnetic brake lead wires of the connection cable to connect a DC power supply (24 VDC±5 %) to the motor.



If a cable for mini Driver is used, the electromagnetic brake cannot be released using a DC power supply. Refer to the operating manual of the driver for how to release the electromagnetic brake.

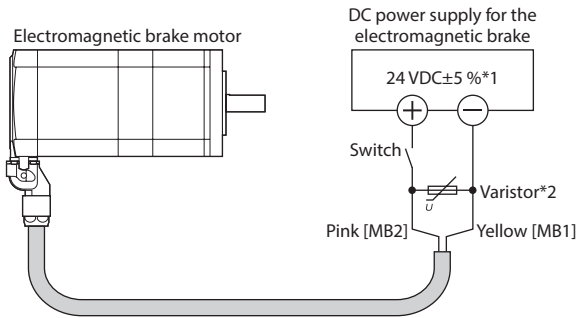

*1 Current capacities of power supplies are as follows.

AZM46: 0.08 A or more

AZM66, AZM69: 0.25 A or more

*2 Use a varistor to protect the contact of the switch and prevent noise.

[Recommended varistor: Z15D121 (SEMITEC Corporation)]

● When a load is installed on the flange face of the Harmonic geared type

With a Harmonic geared type, a load can be installed directly on the gear using the load-mounting screw holes provided on the flange surface.

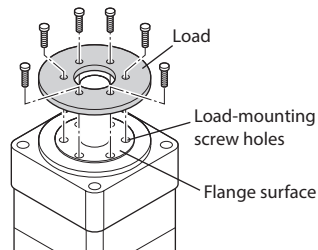

Load-mounting screw hole

Model	Nominal size	Number of screws	Tightening torque [N·m (oz·in.)]	Effective depth of screw thread [mm (in.)]
AZM46	M3	6	1.4 (198)	5 (0.20)
AZM66	M4	6	2.5 (350)	6 (0.24)



- When installing a load on the flange surface, the load cannot be mounted using the key slot in the output shaft.
- Design an appropriate installation layout so that the load will not contact the metal plate or screws used for installing the motor.

● When a coupling or a pulley is installed

When installing a coupling or a pulley on the output shaft, do not apply a strong force to the output shaft. Doing so may damage the encoder (ABZO sensor) due to impact, especially for the standard type motor. For the standard type motor with a parallel key, use the screw hole at the shaft end to install the coupling or the pulley.

1. Install the coupling (pulley) to the output shaft.
2. Attach a screw, a nut, and a washer to the output shaft end, and press the coupling (pulley) to secure while tightening the screw.

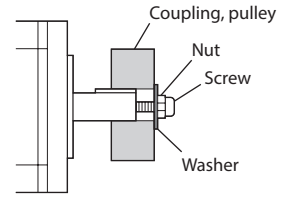

■ Permissible radial load, permissible axial load, and permissible moment load



If the radial load or the axial load exceeds the specified permissible value, repeated load application may cause the output shaft or the bearing (ball bearings) to occur a fatigue failure.



For the **PS** geared type and **PN** geared type, the permissible values are set to values that meet the service life of 20,000 hours when either the radial load or the axial load is applied.

● Permissible radial load

• Standard type

Model	Permissible radial load [N (lb.)]				
	Distance from output shaft end				
	0 mm (0 in.)	5 mm (0.2 in.)	10 mm (0.39 in.)	15 mm (0.59 in.)	20 mm (0.79 in.)
AZM46	35 (7.8)	44 (9.9)	58 (13)	85 (19.1)	–
AZM48	30 (6.7)	35 (7.8)	44 (9.9)	58 (13)	85 (19.1)
AZM66	90 (20)	100 (22)	130 (29)	180 (40)	270 (60)
AZM69					

• TS geared type

Model	Gear ratio	Permissible radial load [N (lb.)]				
		Distance from output shaft end				
		0 mm (0 in.)	5 mm (0.2 in.)	10 mm (0.39 in.)	15 mm (0.59 in.)	20 mm (0.79 in.)
AZM46	3.6, 7.2, 10	20 (4.5)	30 (6.7)	40 (9)	50 (11.2)	–
	20, 30	40 (9)	50 (11.2)	60 (13.5)	70 (15.7)	–
AZM66	3.6, 7.2, 10	120 (27)	135 (30)	150 (33)	165 (37)	180 (40)
	20, 30	170 (38)	185 (41)	200 (45)	215 (48)	230 (51)

• FC geared type

Model	Gear ratio	Permissible radial load [N (lb.)]				
		Distance from output shaft end				
		0 mm (0 in.)	5 mm (0.2 in.)	10 mm (0.39 in.)	15 mm (0.59 in.)	20 mm (0.79 in.)
AZM46	All gear ratios	180 (40)	200 (45)	220 (49)	250 (56)	–
AZM66		270 (60)	290 (65)	310 (69)	330 (74)	350 (78)

• PS geared type

Model	Gear ratio	Permissible radial load [N (lb.)]				
		Distance from output shaft end				
		0 mm (0 in.)	5 mm (0.2 in.)	10 mm (0.39 in.)	15 mm (0.59 in.)	20 mm (0.79 in.)
AZM46	5	70 (15.7)	80 (18)	95 (21)	120 (27)	–
	7.2	80 (18)	90 (20)	110 (24)	140 (31)	–
	10	85 (19.1)	100 (22)	120 (27)	150 (33)	–
	25	120 (27)	140 (31)	170 (38)	210 (47)	–
	36	130 (29)	160 (36)	190 (42)	240 (54)	–
AZM66	5	170 (38)	200 (45)	230 (51)	270 (60)	320 (72)
	7.2	200 (45)	220 (49)	260 (58)	310 (69)	370 (83)
	10	220 (49)	250 (56)	290 (65)	350 (78)	410 (92)
	25	300 (67)	340 (76)	400 (90)	470 (105)	560 (126)
	36	340 (76)	380 (85)	450 (101)	530 (119)	630 (141)
50	380 (85)	430 (96)	500 (112)	600 (135)	700 (157)	

• PN geared type

Model	Gear ratio	Permissible radial load [N (lb.)]				
		Distance from output shaft end				
		0 mm (0 in.)	5 mm (0.2 in.)	10 mm (0.39 in.)	15 mm (0.59 in.)	20 mm (0.79 in.)
AZM46	5	80 (18)	95 (21)	120 (27)	160 (36)	–
	7.2	90 (20)	110 (24)	130 (29)	180 (40)	–
	10	100 (22)	120 (27)	150 (33)	200 (45)	–
AZM66	5	240 (54)	260 (58)	280 (63)	300 (67)	330 (74)
	7.2	270 (60)	290 (65)	310 (69)	340 (76)	370 (83)
	10	300 (67)	320 (72)	350 (78)	380 (85)	410 (92)

• Harmonic geared type

Model	Gear ratio	Permissible radial load [N (lb.)]				
		Distance from output shaft end				
		0 mm (0 in.)	5 mm (0.2 in.)	10 mm (0.39 in.)	15 mm (0.59 in.)	20 mm (0.79 in.)
AZM46	All gear ratios	180 (40)	220 (49)	270 (60)	360 (81)	510 (114)
AZM66	All gear ratios	320 (72)	370 (83)	440 (99)	550 (123)	720 (162)

• Permissible axial load

Type	Model	Gear ratio	Permissible axial load [N (lb.)]
Standard	AZM46 AZM48	–	15 (3.3)
	AZM66 AZM69		30 (6.7)
TS geared	AZM46	All gear ratios	15 (3.3)
	AZM66		40 (9)
FC geared	AZM46	All gear ratios	100 (22)
	AZM66		200 (45)
PS geared	AZM46	All gear ratios	100 (22)
	AZM66		200 (45)
PN geared	AZM46	All gear ratios	100 (22)
	AZM66		200 (45)
Harmonic geared	AZM46	All gear ratios	220 (49)
	AZM66		450 (101)

• Permissible moment load

When installing an arm or table on the flange surface, calculate the moment load using the formula below if the flange surface receives any eccentric load. The moment load should not exceed the permissible value specified in the table.

• Harmonic geared type

Model	Permissible moment load (N-m)
AZM46	5.6
AZM66	11.6

Calculate the axial load and load moment for the Harmonic geared type using the International System of Units (N, N-m).

How to read a code

- m: Mass of a load (kg)
- g: Gravitational acceleration (m/s²)
- F: External force (N)
- L: Overhang distance (m)
- a: Constant (m)
- ΔF: Load applied on the output flange surface (N)
- Fs: Permissible axial load (N)
- ΔM: Load moment (N-m)
- M: Permissible moment load (N-m)

Example 1;

When an external force F(N) is applied on a position overhanging by L (m) from the center of the output flange in the horizontal direction

- Load moment
 $\Delta M = F \cdot L$
 $\Delta M \leq M$
- Axial load
 $\Delta F = F + m \cdot g$
 $\Delta F \leq F_s$

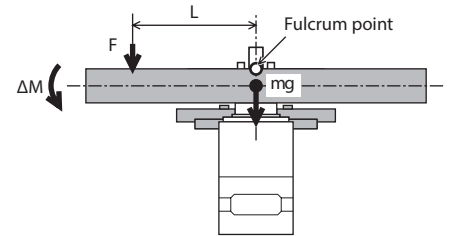

Example 2;

When an external force F(N) is applied on a position overhanging by L (m) from the output flange mounting surface in the vertical direction

- Load moment
 $\Delta M = F \cdot (L + a)$
 $\Delta M \leq M$
- Axial load
 $\Delta F = m \cdot g$
 $\Delta F \leq F_s$

Model	Coefficient "a"
AZM46	0.009
AZM66	0.0114

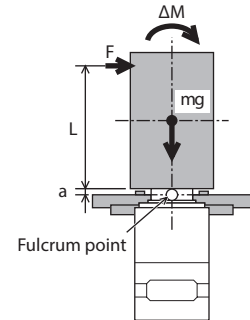

Connection

■ Connecting the cable

1. Remove the connector cap.

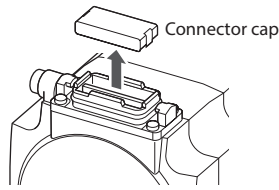

Note Do not damage the O-ring of the connector when removing the connector cap.

2. Connect the connector of the connection cable.
The figure shows an example when using the cable which cable outlet direction is to the output shaft side.
Check the terminal position of the connector before connecting.

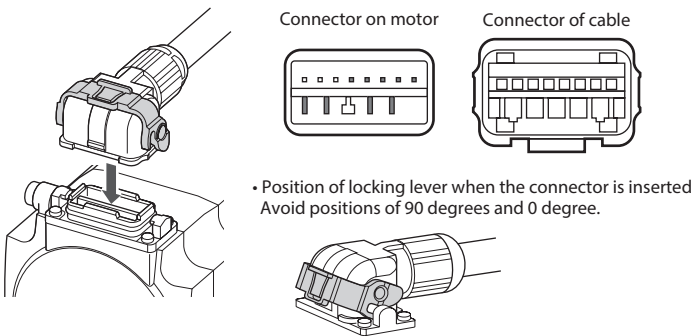

Note If the locking lever is in a state of being turned up to the 90-degree position or down to the 0-degree position, parts around the locking lever and the connector contact with each other, and the connector cannot be connected.

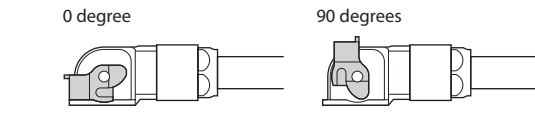

3. Turn down the locking lever to the 0-degree position to fix the connector.

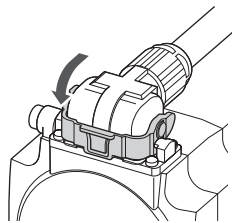

Handling of locking lever

- Do not apply a strong force to the locking lever. If the locking lever is damaged, the connector may not be fixed securely.
- After connecting the connector, securely turn down the locking lever to the 0-degree position to fix the connector.

!WARNING Be sure to turn down the locking lever. If the connector is not fixed, the cable may come off or IP66 may not be satisfied, resulting in fire, electrical shock, or damage to equipment.

■ Detaching the cable

Turn up the locking lever and pull out the connector.

memo Turning up the locking lever to the 90-degree position will detach the connector at the same.

■ Grounding

It is not necessary to provide a protective earth for motors of the DC input type. Ground the functional earth terminal (M4) if necessary. AC power input motors can be grounded by connecting the Protective Earth wire of the connection cable to the Protective Earth Terminal of the driver. However, if grounding the Protective Earth wire of the connection cable does not satisfy the grounding resistance required by the applicable standard of the equipment, the Protective Earth Terminal of the motor must also be grounded.

memo Do not share the grounding wire with a welder or power equipment.

1) Grounding the Protective Earth wire of the motor

Connect the Protective Earth wire of the connection cable to the Protective Earth Terminal of the driver.

Description	Connection cable	Flexible connection cable
Conductor wire size	AWG 18 (0.75 mm ²)	AWG 18 (0.75 mm ²)
Maximum conductor resistance	21.8 Ω/km	25.6 Ω/km
Tightening torque	1.2 N·m (170 oz-in)	

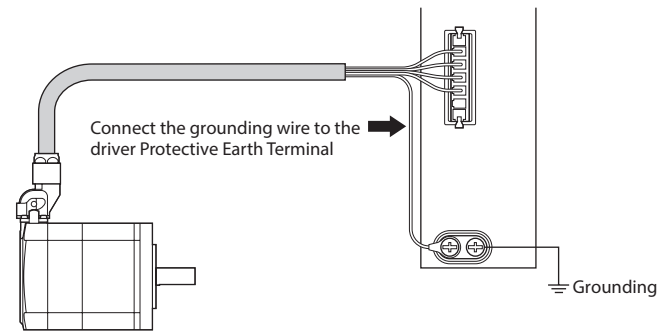

2) Grounding the Protective Earth Terminal of the motor

Securely ground the Protective Earth Terminal of the motor.

Use a round terminal, a washer, and a screw when grounding. A grounding wire and a crimp terminal are not included.

- Grounding wire: AWG18 (0.75 mm²) or thicker
- Screw size: M4
- Tightening torque: 1.2 N·m (170 oz-in)

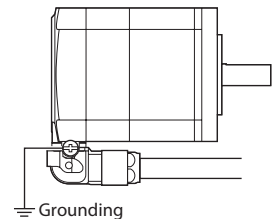

Inspection and maintenance

■ Inspection

It is recommended that periodic inspections are conducted for the items listed below after each operation of the motor. If an abnormality is found, discontinue any use and contact your nearest Oriental Motor sales office.

● Inspection item

- Check if any of the mounting screws of the motor is loose.
- Check if the bearing part (ball bearings) of the motor generates unusual noises.
- Check if a damage or stress is applied on the connection cable.
- Check if any of the connection parts of the driver is loose.
- Check if the output shaft and the load shaft are out of alignment.
- Check if the locking lever of the connection cable is damaged.
- Check if the locking lever of the connection cable is come off.

■ Warranty

Check on the Oriental Motor Website for the product warranty.

■ Disposal

Dispose the product correctly in accordance with laws and regulations, or instructions of local governments.

Connection cables

The model name of the connection cable varies depending on the outlet direction from the motor. Refer to the figures.

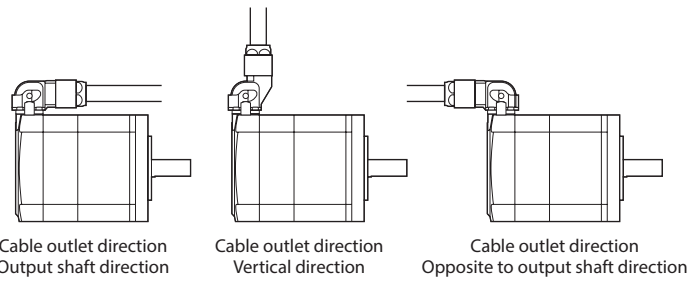

When installing the motor on a moving part, use a flexible cable.

Connection cables

A connection cable varies depending on a driver combined. The box (■) in the driver model indicates an alphabet representing the driver type.

The box (□□□) in the cable model indicates a number representing the cable length.

Example) Cable length 1 m (3.3 ft.): **CCM010Z1AFF**

- For AC power input
(Driver model: **AZD-A**, **AZD-A■**, **AZD-C**, **AZD-C■**)

Cable length [m (ft.)]: 1 (3.3), 2 (6.6), 3 (9.8), 5 (16.4), 7 (23.0), 10 (32.8)

Cable outlet direction	For motor/encoder	For motor/encoder/ electromagnetic brake
Output shaft direction	CCM□□□Z1AFF	CCM□□□Z1BFF
Vertical direction	CCM□□□Z1AVF	CCM□□□Z1BVF
Opposite to output shaft direction	CCM□□□Z1ABF	CCM□□□Z1BBF

- For DC power input (Driver model: **AZD-K**, **AZD-K■**)

Cable length [m (ft.)]: 0.5 (1.6), 1 (3.3), 2 (6.6), 3 (9.8), 5 (16.4), 7 (23.0), 10 (32.8)

Cable outlet direction	For motor/encoder	For motor/encoder/ electromagnetic brake
Output shaft direction	CCM□□□Z1CFF	CCM□□□Z1DFF
Vertical direction	CCM□□□Z1CVF	CCM□□□Z1DVF
Opposite to output shaft direction	CCM□□□Z1CBF	CCM□□□Z1DBF

- For mini Driver (Driver model: **AZD-KR■**)

Cable length [m (ft.)]:
0.2 (0.7), 0.5 (1.6), 1 (3.3), 2 (6.6), 3 (9.8), 5 (16.4), 7 (23.0), 10 (32.8)

Cable outlet direction	For motor/encoder	For motor/encoder/ electromagnetic brake
Output shaft direction	CCM□□□Z1EFF	
Vertical direction	CCM□□□Z1EVF	
Opposite to output shaft direction	CCM□□□Z1EBF	

Flexible connection cables

A connection cable varies depending on a driver combined.

The box (■) in the driver model indicates an alphabet representing the driver type.

The box (□□□) in the cable model indicates a number representing the cable length.

Example) Cable length 1 m (3.3 ft.): **CCM010Z1AFR**

- For AC power input
(Driver model: **AZD-A**, **AZD-A■**, **AZD-C**, **AZD-C■**)

Cable length [m (ft.)]: 1 (3.3), 2 (6.6), 3 (9.8), 5 (16.4), 7 (23.0), 10 (32.8)

Cable outlet direction	For motor/encoder	For motor/encoder/ electromagnetic brake
Output shaft direction	CCM□□□Z1AFR	CCM□□□Z1BFR
Vertical direction	CCM□□□Z1AVR	CCM□□□Z1BVR
Opposite to output shaft direction	CCM□□□Z1ABR	CCM□□□Z1BBR

- For DC power input (Driver model: **AZD-K**, **AZD-K■**)

Cable length [m (ft.)]: 0.5 (1.6), 1 (3.3), 2 (6.6), 3 (9.8), 5 (16.4), 7 (23.0), 10 (32.8)

Cable outlet direction	For motor/encoder	For motor/encoder/ electromagnetic brake
Output shaft direction	CCM□□□Z1CFR	CCM□□□Z1DFR
Vertical direction	CCM□□□Z1CVR	CCM□□□Z1DVR
Opposite to output shaft direction	CCM□□□Z1CBR	CCM□□□Z1DBR

- For mini Driver (Driver model: **AZD-KR■**)

Cable length [m (ft.)]: 0.5 (1.6), 1 (3.3), 2 (6.6), 3 (9.8), 5 (16.4), 7 (23.0), 10 (32.8)

Cable outlet direction	For motor/encoder	For motor/encoder/ electromagnetic brake
Output shaft direction	CCM□□□Z1EFR	
Vertical direction	CCM□□□Z1EVR	
Opposite to output shaft direction	CCM□□□Z1EBR	

General specifications

Degree of protection	IP66*1 *2 (excluding the mounting surface and the connector on the driver side of the connecting cable)	
Operating environment	Ambient temperature	0 to +40 °C [+32 to +104 °F]*3 (non-freezing)
	Humidity	85 % or less (non-condensing)
	Altitude	Up to 1,000 m (3,300 ft.) above sea level
	Surrounding atmosphere	No corrosive gas or dust. No exposure to oil.
Storage environment Shipping environment	Ambient temperature	-20 to +60 °C [-4 to +140 °F] (non-freezing)
	Humidity	85 % or less (non-condensing)
	Altitude	Up to 3,000 m (10,000 ft.) above sea level
	Surrounding atmosphere	No corrosive gas or dust. No exposure to water or oil.
Insulation resistance	100 MΩ or more when 500 VDC megger is applied between the following places: • Between case and motor windings • Between case and electromagnetic brake windings	
Dielectric strength	Sufficient to withstand the specified voltage applied between the following places for 1 minute: • AC power input type • Between case and motor windings: 1.5 kVAC 50/60 Hz • Between case and electromagnetic brake windings: 1.5 kVAC 50/60 Hz • DC power input type • Between case and motor windings: 1.0 kVAC 50/60 Hz • Between case and electromagnetic brake windings: 1.0 kVAC 50/60 Hz	

*1 When the connection cable is connected.

*2 Do not install the product underwater or under high water pressure.

*3 Based on measurement conditions of Oriental Motor.

Regulations and standards

■ UL Standards

This product is recognized by UL under the UL and CSA Standards. Check the "APPENDIX UL Standards for **AZ Series**" for recognition information about UL Standards.

■ CE Marking / UKCA Marking

This product is affixed with the marks under the following directive/regulations.

● EU Low Voltage Directive / UK Electrical Equipment (Safety) Regulations (AC power input type)

- This product cannot be used in IT power distribution systems.
- Isolate the motor cable, the power supply cable and other drive cables from the signal cables by means of double insulation.

● Installation conditions

- To be incorporated in equipment
- Overvoltage category: II
- Pollution degree: 3
- Degree of protection: IP66
- Protection against electric shock: Class I

● EU EMC Directive / UK EMC Regulations

The EMC test is conducted in a state where the motor is connected to the driver. The driver that is combined with the motor complies with the EMC Directive/Regulations. Refer to the operating manual of the driver for details.

● EU RoHS Directive / UK RoHS Regulations

This product does not contain the substances exceeding the restriction values.

- Unauthorized reproduction or copying of all or part of this manual is prohibited.
- Oriental Motor shall not be liable whatsoever for any problems relating to industrial property rights arising from use of any information, circuit, equipment or device provided or referenced in this manual.
- Characteristics, specifications and dimensions are subject to change without notice.
- While we make every effort to offer accurate information in the manual, we welcome your input. Should you find unclear descriptions, errors or omissions, please contact your nearest Oriental Motor sales office.
- **Orientalmotor**, **QSTEP**, and ABZO sensor are registered trademarks or trademarks of Oriental Motor Co., Ltd., in Japan and other countries. Modbus is a registered trademark of the Schneider Automation Inc.

© Copyright ORIENTAL MOTOR CO., LTD. 2021

Published in December 2024

- Please contact your nearest Oriental Motor office for further information.

ORIENTAL MOTOR U.S.A. CORP
Technical Support Tel:800-468-3982
8:30am EST to 5:00pm PST (M-F)

ORIENTAL MOTOR (EUROPA) GmbH
Schiebsstraße 44, 40549 Düsseldorf, Germany
Technical Support Tel:00 800/22 55 66 22

ORIENTAL MOTOR (UK) LTD.
Unit 5 Faraday Office Park, Rankine Road,
Basingstoke, Hampshire RG24 8QB UK
Tel:+44-1256347090

ORIENTAL MOTOR (FRANCE) SARL
Tel:+33-1 47 86 97 50

ORIENTAL MOTOR ITALIA s.r.l.
Tel:+39-02-93906347

ORIENTAL MOTOR CO., LTD.
4-8-1 Higashiueno, Taito-ku, Tokyo 110-8536
Japan
Tel:+81-3-6744-0361
www.orientalmotor.co.jp/ja

ORIENTAL MOTOR ASIA PACIFIC PTE. LTD.
Singapore
Tel:1800-842-0280

ORIENTAL MOTOR (MALAYSIA) SDN. BHD.
Tel:1800-806-161

ORIENTAL MOTOR (THAILAND) CO., LTD.
Tel:1800-888-881

ORIENTAL MOTOR (INDIA) PVT. LTD.
Tel:1800-120-1995 (For English)
1800-121-4149 (For Hindi)

TAIWAN ORIENTAL MOTOR CO., LTD.
Tel:0800-060708

SHANGHAI ORIENTAL MOTOR CO., LTD.
Tel:400-820-6516

INA ORIENTAL MOTOR CO., LTD.
Korea
Tel:080-777-2042